

Blade in Y Position

Blade in Inverted-Y Position

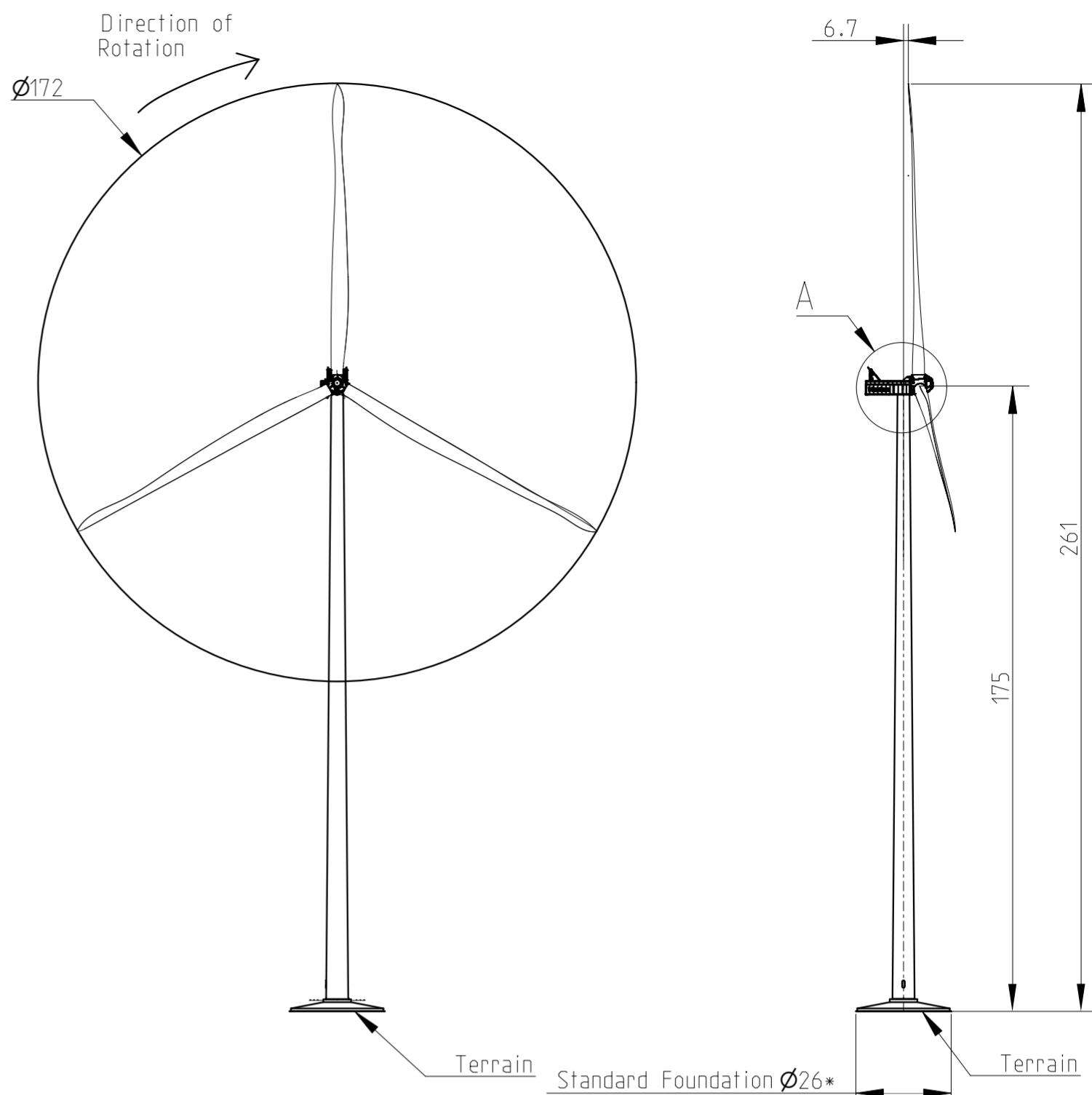

Blade in Horizontal Position

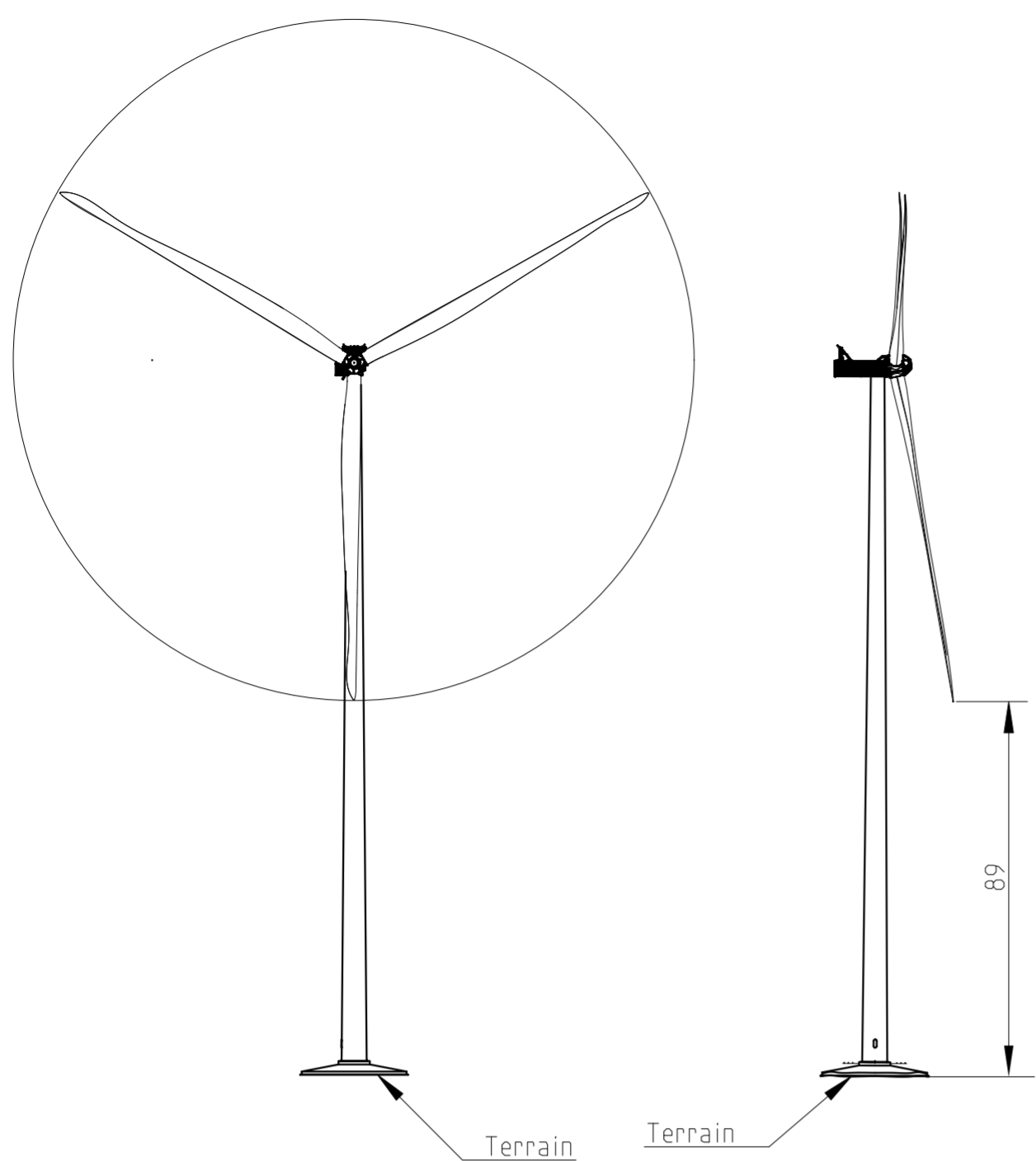
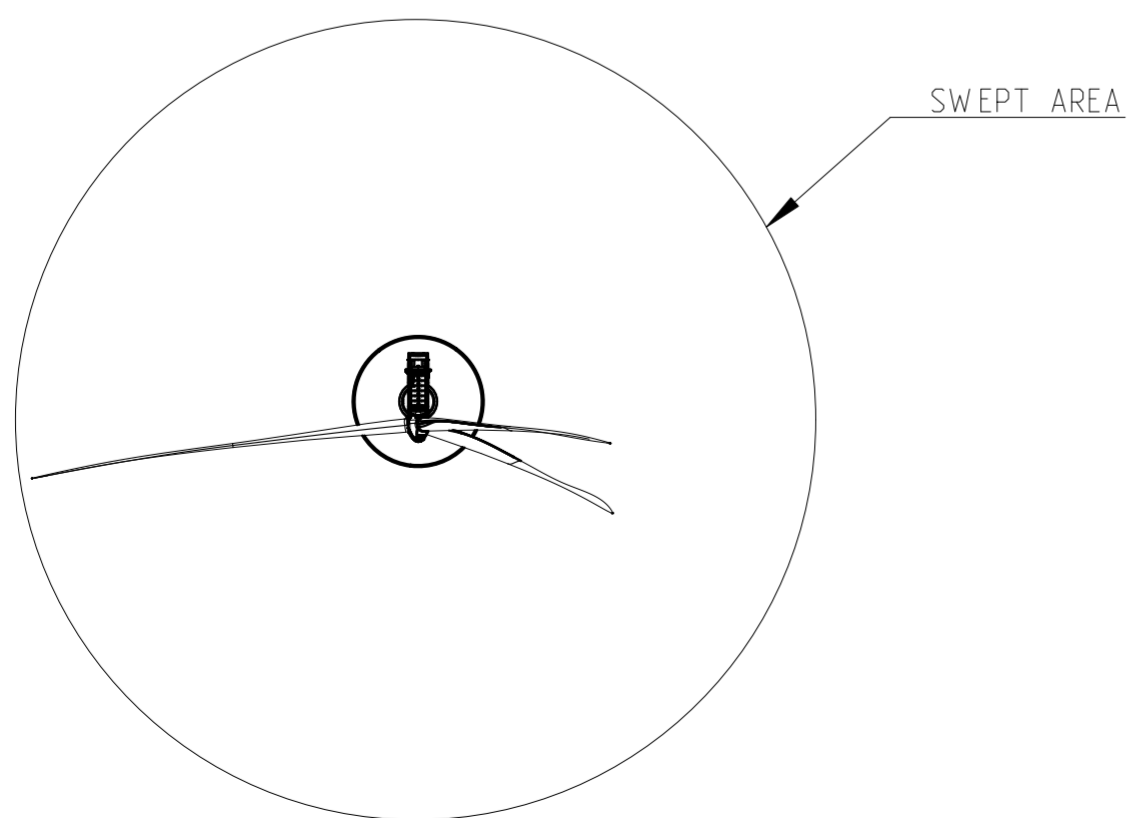
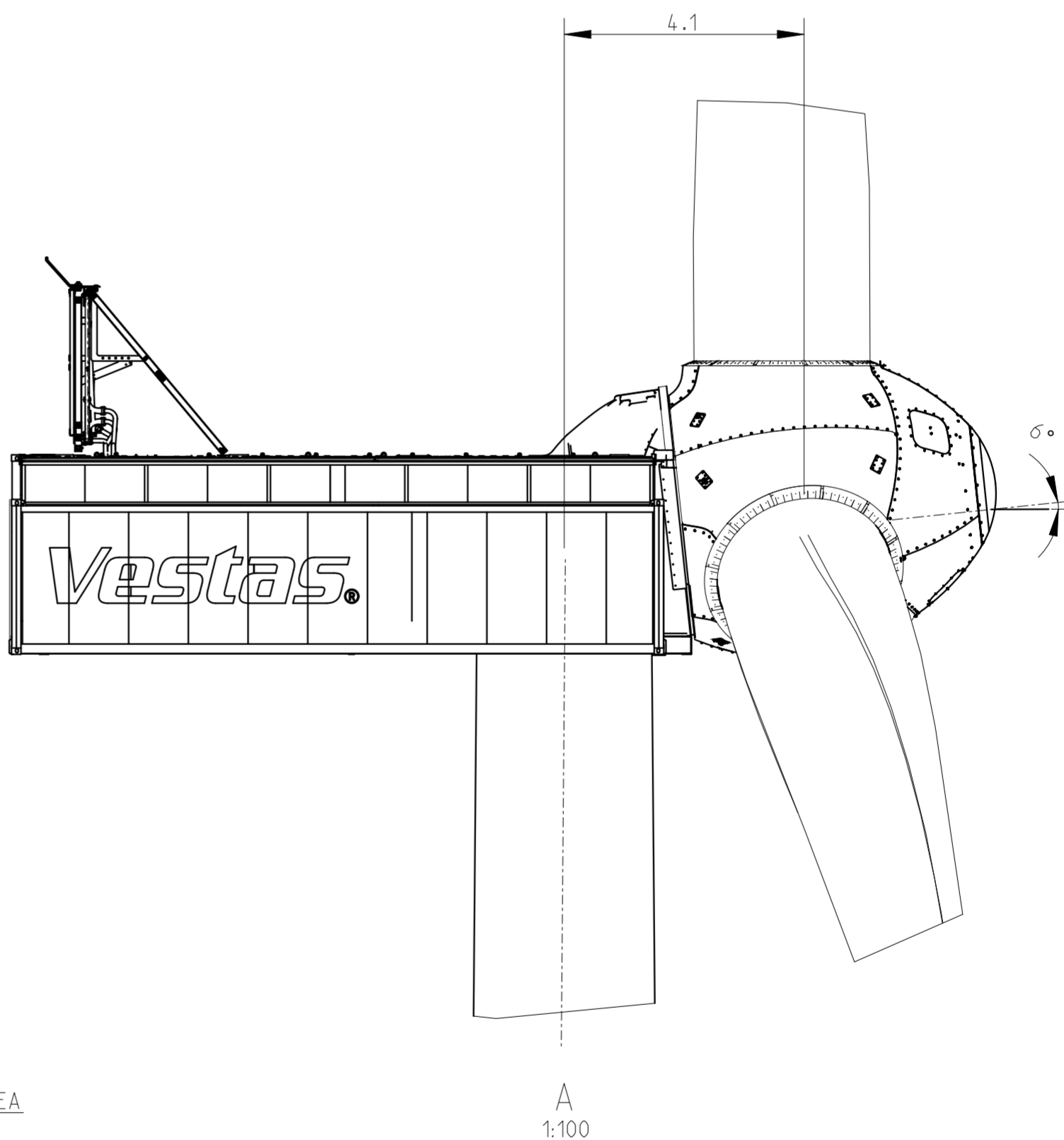
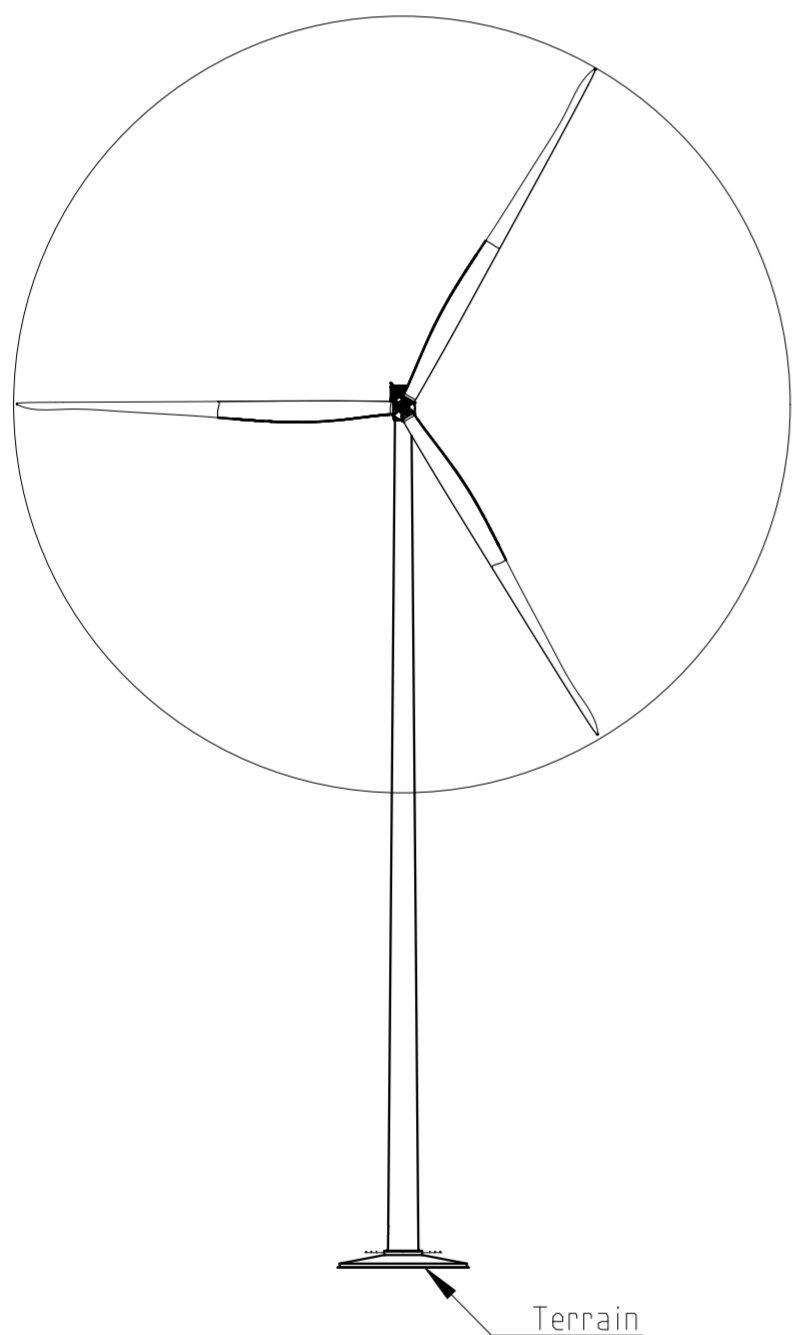

Drawing is only for documentation of dimensions. Actual turbine design may differ in visual appearance.

*Foundation diameter is indicative and depends on actual site condition

All dimensions are shown in meters

Item no.	0114-1754	Mass (kg)	0	Certificate	-	Format	A2	Status	In Work	Revised by	-	Created date	2022/12/07	Created by	KANAH
Material specification	-	Scale	1:1500	Change no.	-	PDM ver.	.0	Approved date	-	Approved by	-				
						Proj.	V172 HH175								
						Pro/E									
						Metric	Replaces / Copy of	Drawing no.		Ver.	Sheet				
						Dimensions shown in mm unless otherwise specified	-	0114-1754		3	1 of 1				

WARNING: PROPRIETARY AND CONFIDENTIAL INFORMATION. This document and the information set forth herein are confidential and proprietary to Vestas Wind Systems A/S. It contains trade secrets, and independent economic value, actual or potential, may be derived from the document/information not being generally known, in consideration of you receiving this document you agree (i) to keep the information secret (ii) only to use the information for the purpose specifically agreed with Vestas (iii) not to disclose directly or indirectly any part of the information to any third party and (iv) not to make copies or reproductions thereof by whatsoever means or undertake any qualitative or quantitative analysis, reverse engineering or replication.